

10.0VA

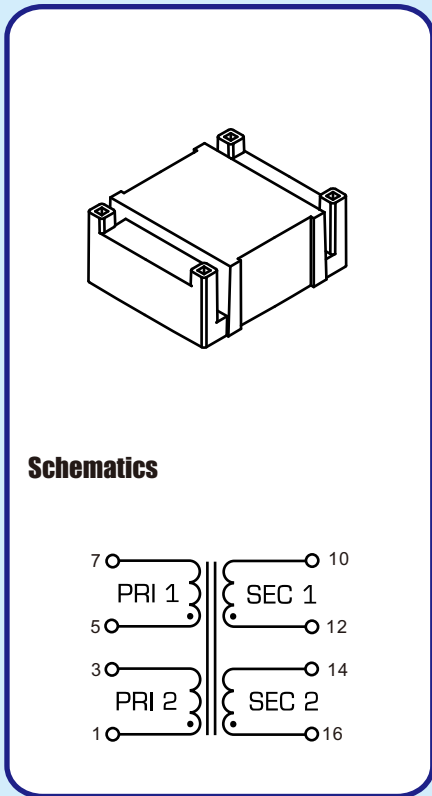

- Core type UI30
- Rated power output - 10.0VA
- Input voltage - 115VX2, 50/60Hz
- Insulation class - Class B (130°C)
- Ambient temperature (ta) - 50°C
- Self-extinguishing material
- Split-bobbin design
- Dielectric strength - 3,750Vrms
- Potted under vacuum
- Weight: 260g



Schematics

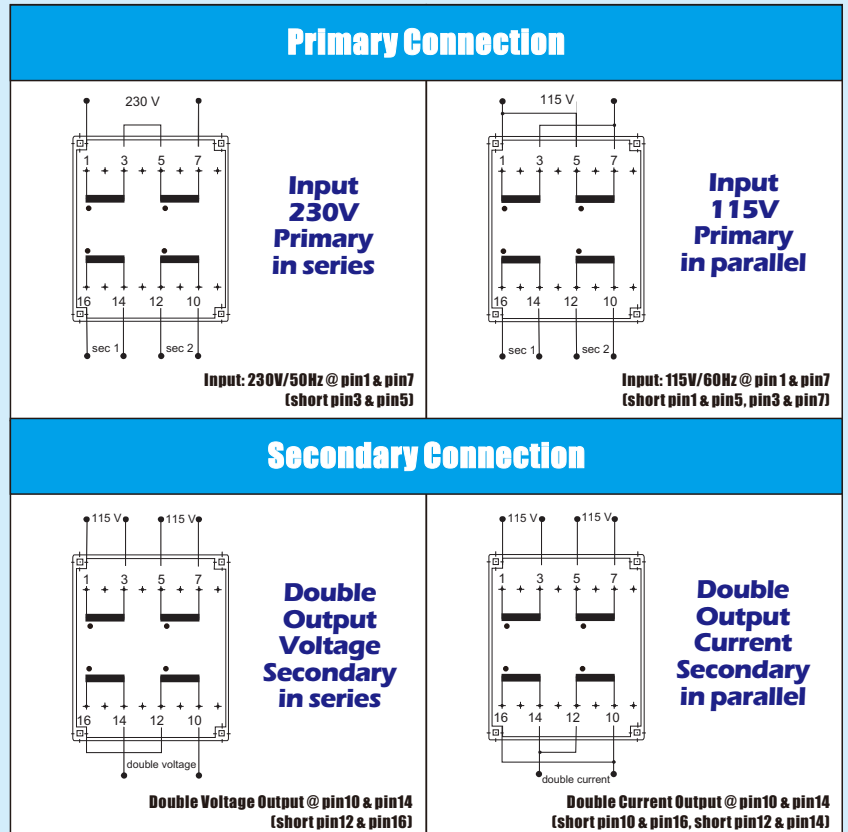
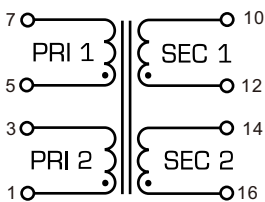

Note: Recommended PCB layout for primary and secondary in series or in parallel. Unused pins are omitted for standard parts and it can be provided upon request.

Part Number	Primary (V)	Secondary (V)	Secondary (mA)	No-Load Voltage (V)	Ambient Temperature
YZU30XD100-0605B	2X115	2X6	2X833.3	2X7.9	ta 50/B
YZU30XD100-0905B	2X115	2X9	2X555.6	2X11.9	ta 50/B
YZU30XD100-1205B	2X115	2X12	2X416.7	2X15.9	ta 50/B
YZU30XD100-1505B	2X115	2X15	2X333.3	2X19.8	ta 50/B
YZU30XD100-1805B	2X115	2X18	2X277.8	2X23.7	ta 50/B
YZU30XD100-2105B	2X115	2X21	2X238.1	2X27.7	ta 50/B
YZU30XD100-2405B	2X115	2X24	2X208.3	2X31.7	ta 50/B

Dimensions (mm):

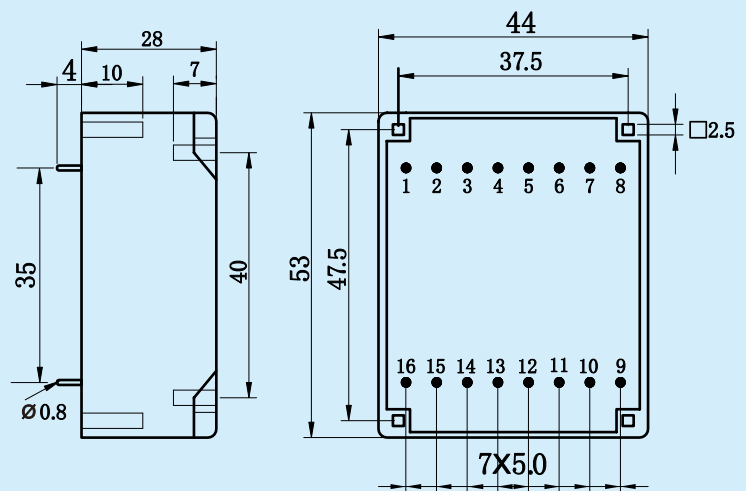

Front View

Bottom View